

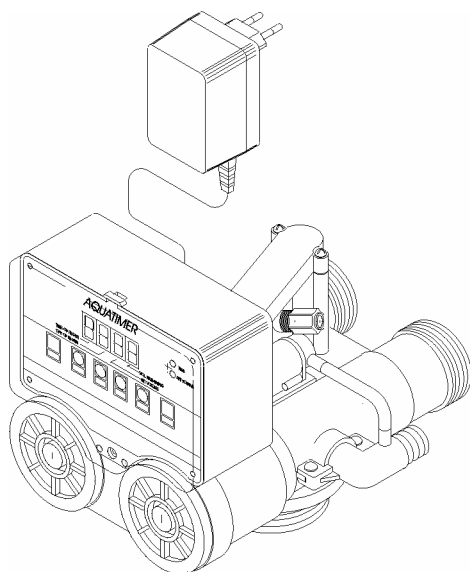

## V230 VALVE OPERATING MANUAL



DOCUMENT	REVISION	REVISION NOTES	DATE
MAN0029	A	BOZZA	19/06/98
MAN0029	B	EMISSIONE	

## Index

➤ General Features – Technical Specification	4
➤ Dimension	5
➤ Softening Function Schemes	6
➤ Softening Version Schemes	7
➤ Demineralisation Version Schemes	9
➤ Variations of Use = Controller/Pilot Valves Connections	10
➤ Injectors & Flow Controls	13
➤ Components of Standard Base Valve	14
➤ Standard Volume Version	15
➤ Standard Filtration Version	16
➤ Duplex and Demineralisation Valve Version	17
➤ Table for Controllers Selection	18
➤ Automatic Remote By-pass for Softners & for Filter	19
➤ Automatic Remote By-pass Components	20
➤ Automatic By-pass Function	21
➤ Chlorine producer Components	22
➤ Tips and Suggestions	23
➤ Spare Parts Kit	24
➤ Accessories and Spare Parts	25
➤ Intervention of ordinary maintenance	26

## GENERAL FEATURES

"V230" valves are the essential elements in building the following systems:

- simplex, duplex or multi-tank softening (decalcification) systems for domestic, laboratory and industrial use;
- simplex or duplex demineralisation and dealkalisation systems for laboratory and industrial use and all other uses requiring water with characteristics of guaranteed quality;
- simplex or duplex filtering systems for all of the previous applications.

The valves are made with materials that guarantee utmost resistance and quality. They are available with a vast range of controllers for every operation phase of service and regeneration, starting from the simplest electronic basic controller with weekly clock to the sophisticated electronic controllers in various models which enable volume, volume-time control and salinity control in MicroSiemens/cm, etc.

In the electronic systems, all the intervention times of operation phases can be programmed in relation to system type and dimension.

For specific controller features, see the relative manual.

## TECHNICAL SPECIFICATIONS

Operating pressure	From 1.5 to 6 bar
Maximum water flow with load loss of 1bar	44.09 US gpm. 25.7 UK gpm
See Table 1 for value variables	-
Backwash water flow	max. 17.64 US gpm 11
Slow rinse water flow	0.44 to 2.65 US gpm 0.16
Fast rinse water flow (down-flow)	max. 24.25 US gpm
Static resistance to pressure	22 bar
Maximum quantity of regenerative resin	200 l.
Operating temperature	From 5 to 40°C
Materials of main components	ABS+FV
Tank connection	Ø 4"
Input output attachments	2" gas male

### PRESSURE DROP

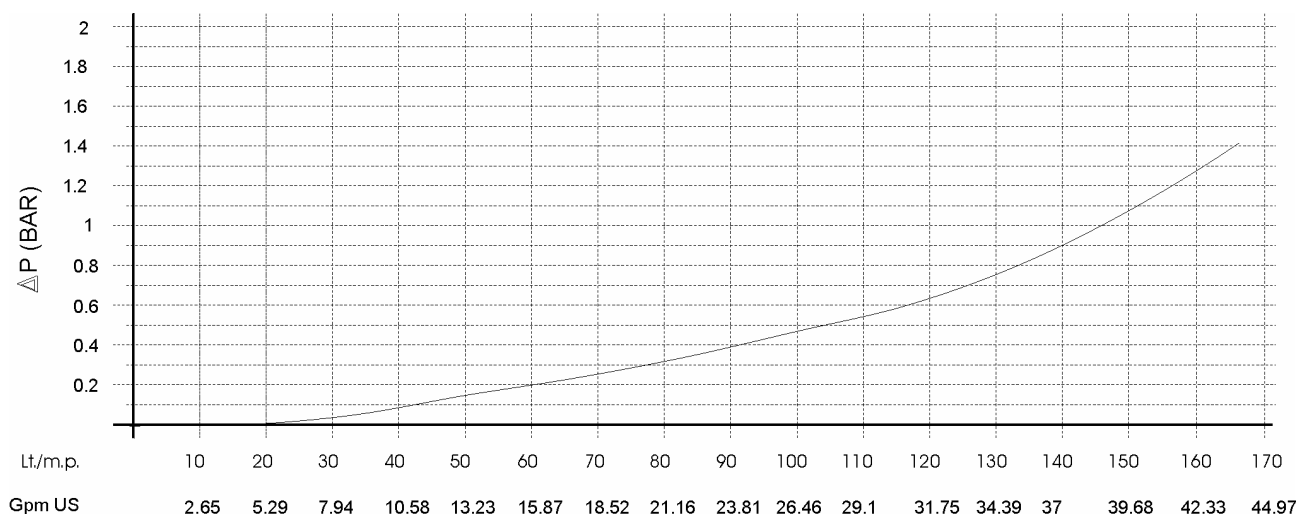

For cod. 494-\* see page 24

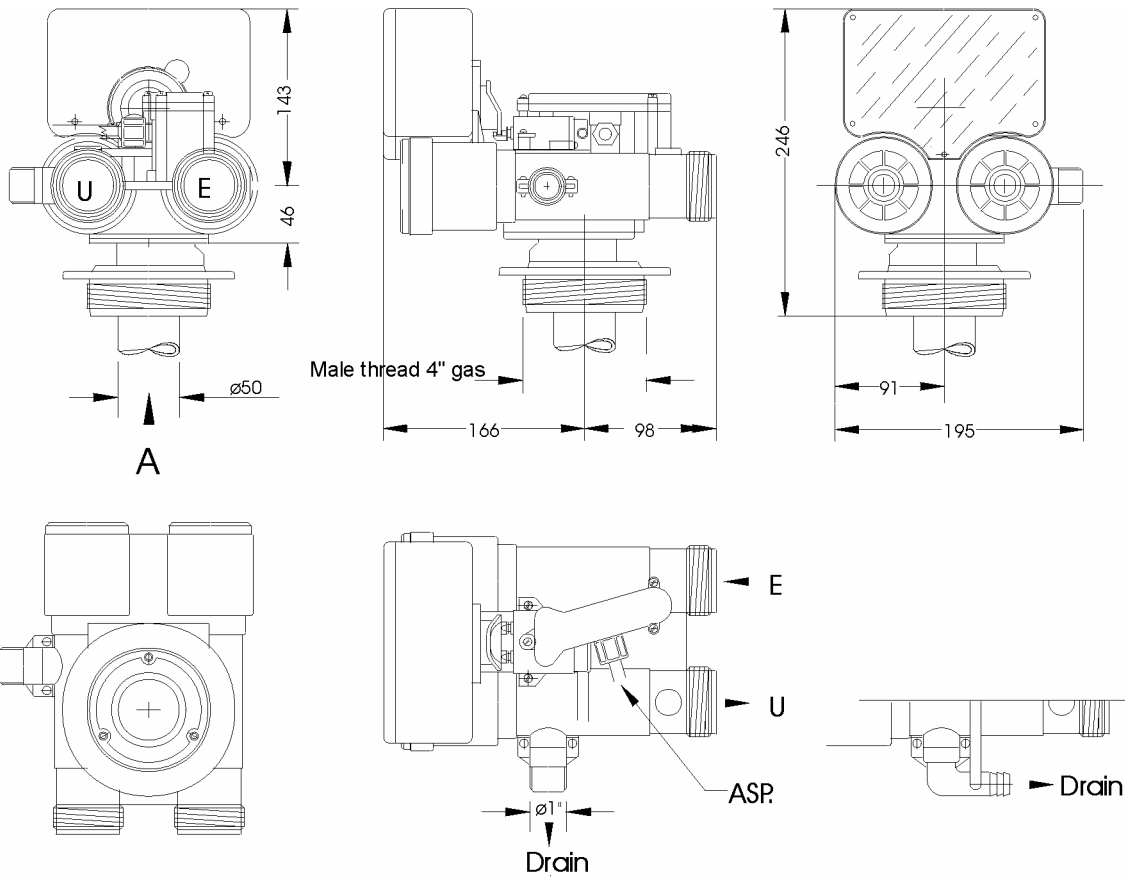

Male thread 2" gas

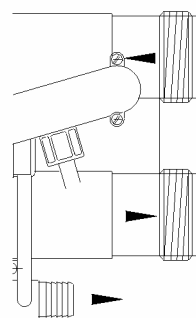

E

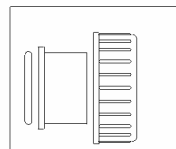

CODE 494-\*

U

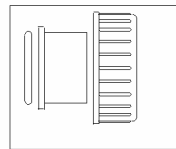

CODE. 494-\*

**FUNCTION SCHEMES**
  
**SOFTENING**

**Service**

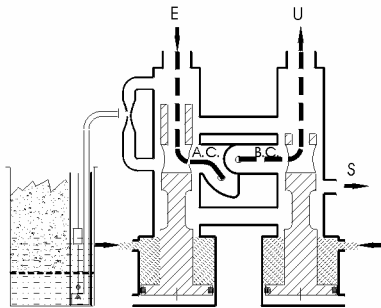

**Backwash**

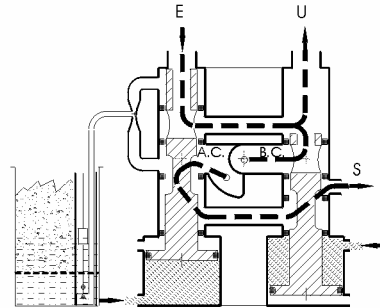

**Brine draw**

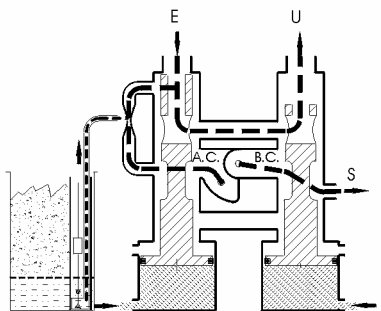

**Slow rinse**

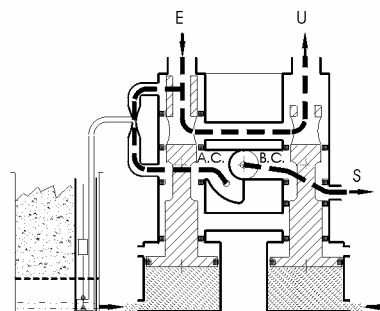

**Fast rinse**

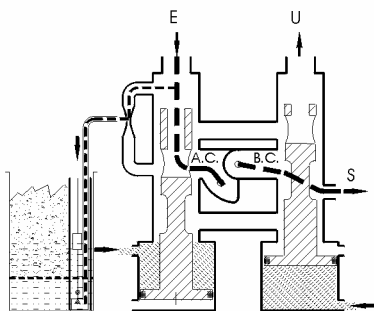

A) Duplex softening scheme with two brine measure valves, slow rinse, 3V output valve. 5 pilot valve controller.

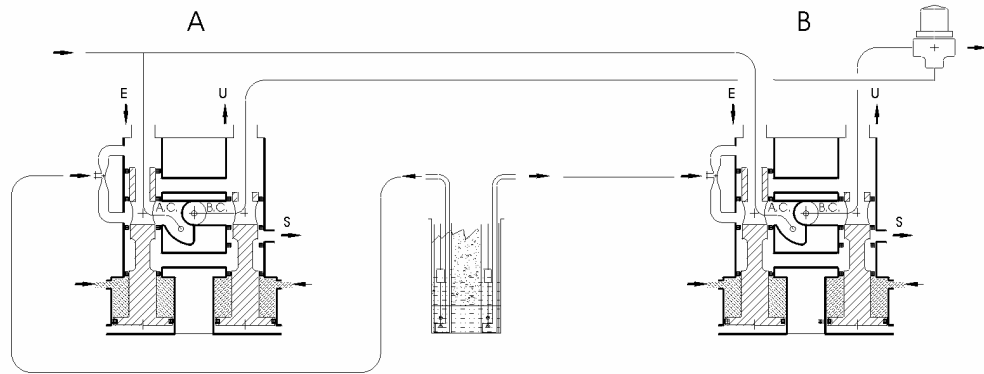

B) Duplex softening scheme with brine measure valve, slow rinse and automatic/dynamic device to determine brine-draw line. 5 pilot valve controller. 3V valve.

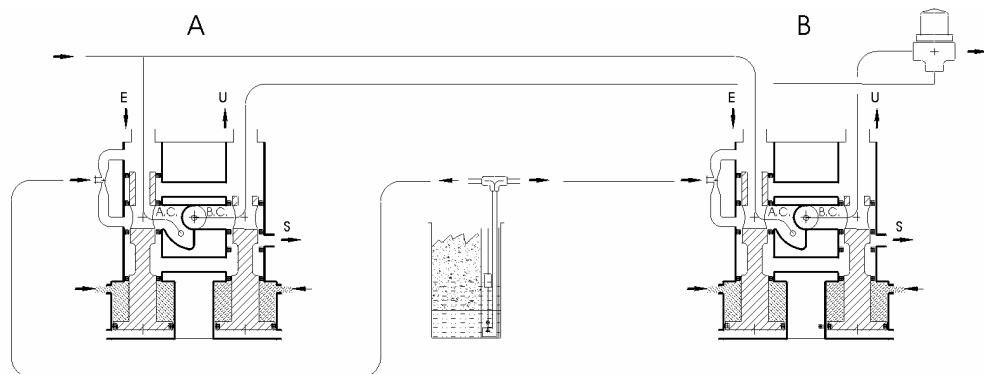

C) Duplex softening scheme without slow rinse, (salt-brine container fed separately), without brine-measure valve. 5 pilot valve controller. 3V valve.

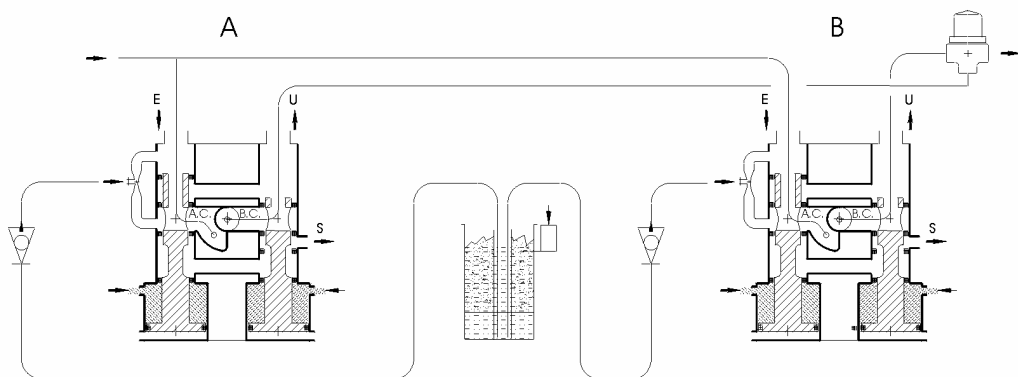

E) Duplex softening scheme with slow rinse (Salt/brine container fed separately) without brine-measure valve. 7 pilot valve controller. 3V valve.

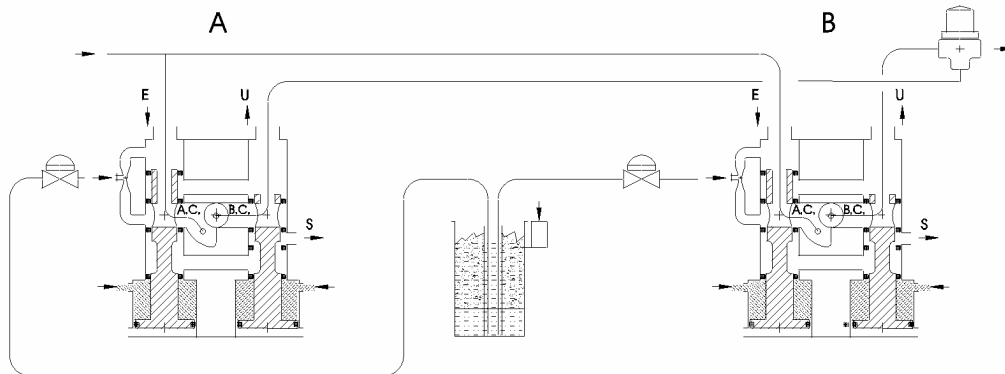

F) Duplex softening scheme without slow rinse (Salt/brine container fed separately) Two output valves "A" and "B". 5 pilot valve controller. Without brine measure valve.

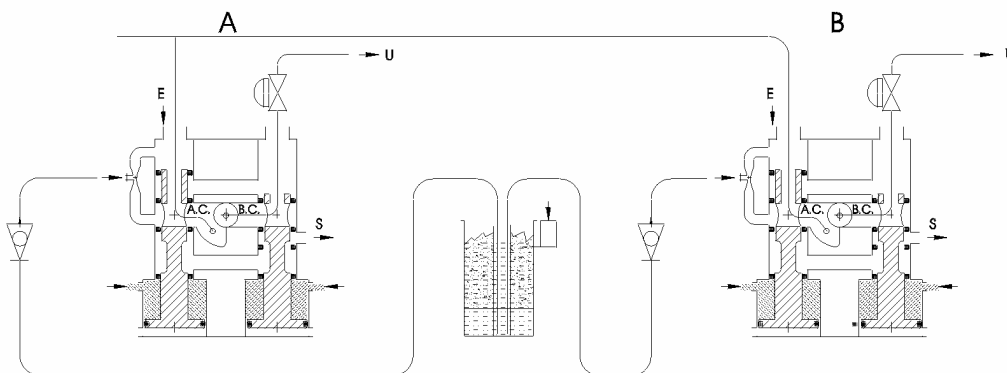

G) Duplex softening scheme with slow rinse (Salt/brine container fed separately) Two output valves "A" and "B". 7 pilot valve controller. Without brine measure valve.

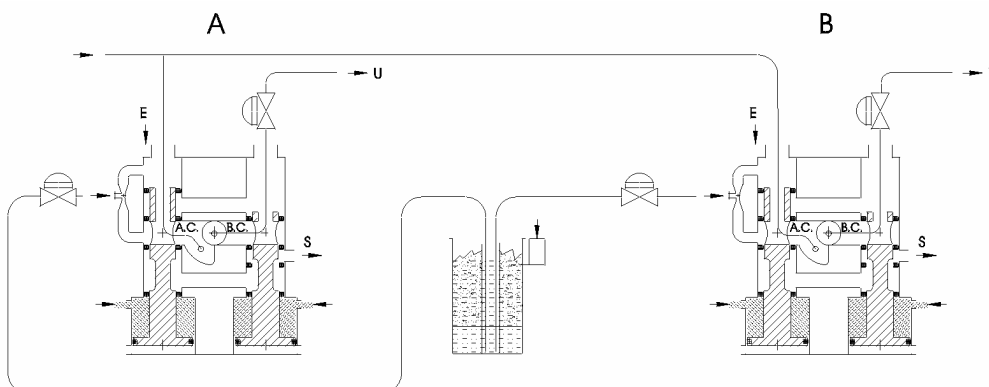



H) Demineralisation scheme without valves for slow rinse, 5 pilot valve controller. Attention!  
Dissuaded application

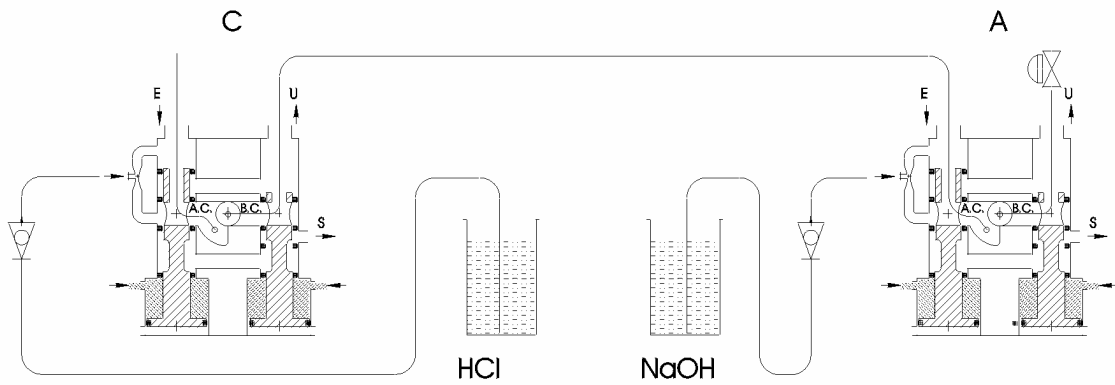

I) Demineralisation scheme with valves for slow rinse, 7 pilot valve controller. Attention!  
Application Recommended

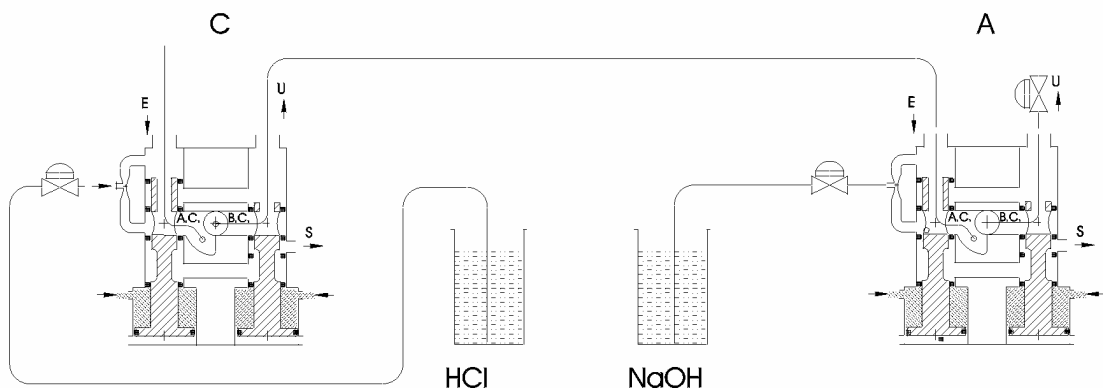

**VARIATION OF USE**

Duplex softening connections referring to schemes "A", "B", "C" page 7.

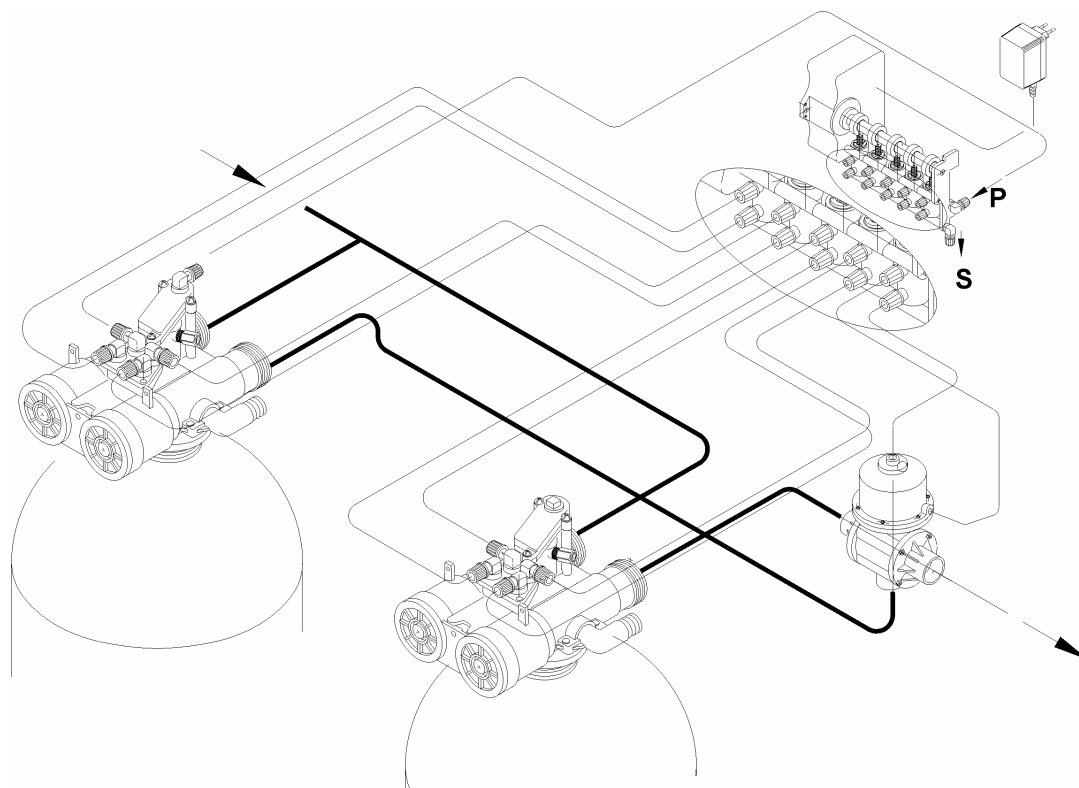

Duplex softening connections referring to schemes "F" page 8.

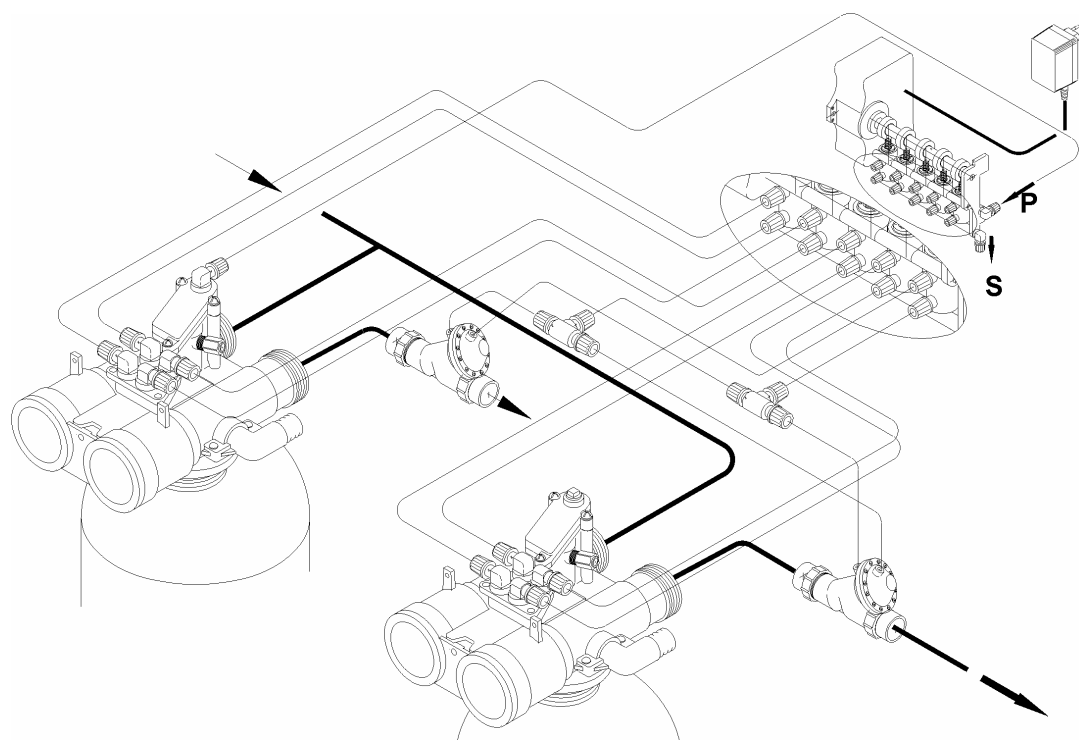

Duplex softening connections referring to schemes "E" page 8.

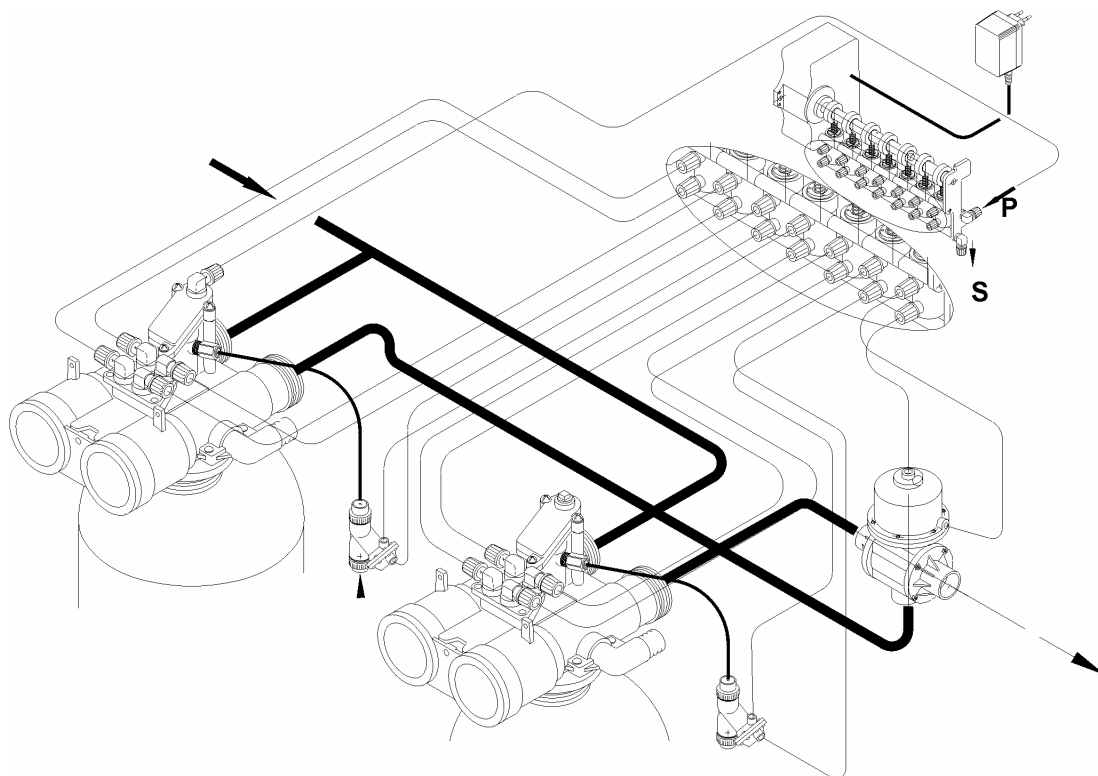

Duplex softening connections referring to schemes "G" page 8.

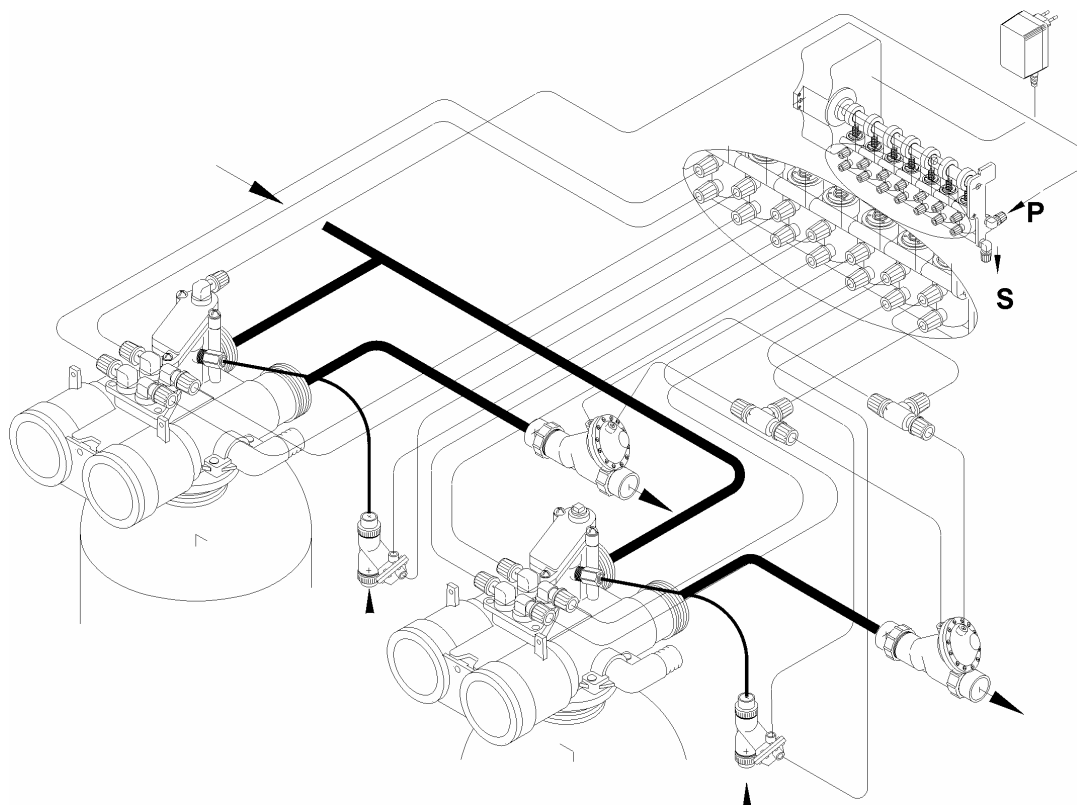

Duplex demineralisation connections referring to schemes "H" page 9.

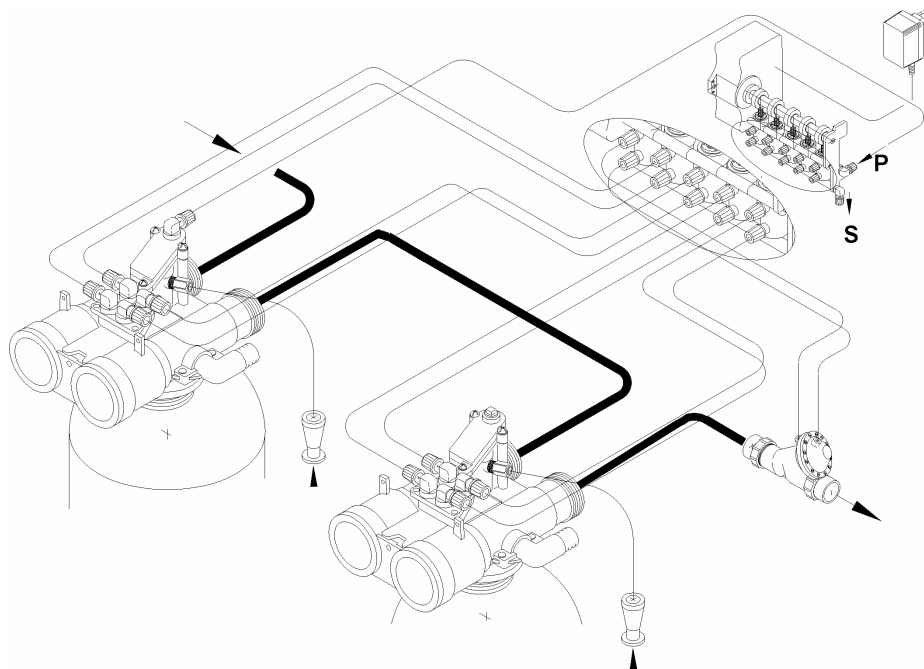

Duplex demineralisation connections referring to schemes "I" page 9.

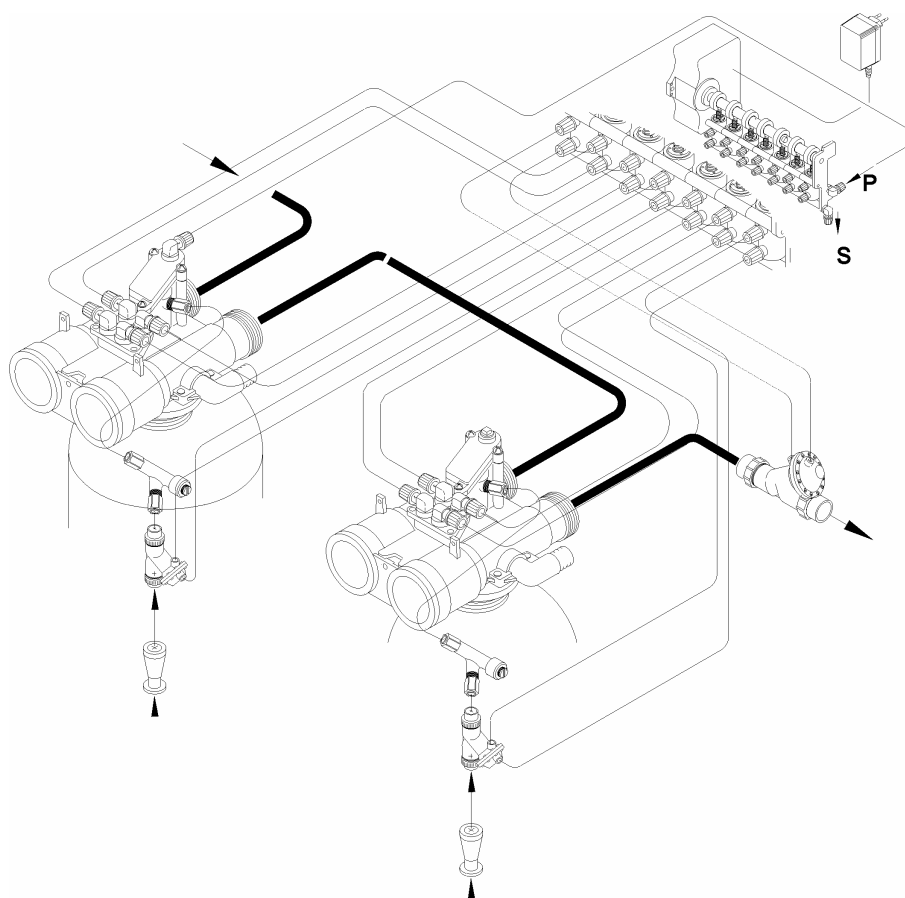

### INJECTOR AND FLOW CONTROL TABLE

PRESSIONE PRESSURE		BAR	2	2.5	3	3.5	4	4.5	5	5.5
		PSI	29	37	44	51	59	66	73	81
EIETTORE MARRONE BROWN INJECTOR	ASPIRATO BRINE DELIVERY	L/h Gpm US	27 0.12	30 0.13	33 0.14	39 0.17	43 0.19	44 0.19	45 0.2	
	MOTRICE MOTIVE/SLOW RINSE DELIVERY	L/h Gpm US	59 0.26	66 0.29	72 0.32	78 0.34	83 0.37	88 0.39	93 0.41	
	PORTATA TOTALE REGENERATION DELIVERY	L/h Gpm US	88 0.39	96 0.42	105 0.46	117 0.52	126 0.55	132 0.58	138 0.61	
EIETTORE BLU BLUE INJECTOR	ASPIRATO BRINE DELIVERY	L/h Gpm US	51 0.22	60 0.26	66 0.29	78 0.34	84 0.37	87 0.38	90 0.4	
	MOTRICE MOTIVE/SLOW RINSE DELIVERY	L/h Gpm US	73 0.32	81 0.36	89 0.39	96 0.42	103 0.45	109 0.48	115 0.51	
	PORTATA TOTALE REGENERATION DELIVERY	L/h Gpm US	124 0.55	141 0.62	155 0.68	174 0.77	187 0.82	196 0.86	205 0.9	
EIETTORE ROSSO RED INJECTOR	ASPIRATO BRINE DELIVERY	L/h Gpm US	111 0.49	133 0.59	149 0.66	173 0.76	180 0.79	183 0.81	186 0.82	189 0.83
	MOTRICE MOTIVE/SLOW RINSE DELIVERY	L/h Gpm US	159 0.7	177 0.78	194 0.85	210 0.92	224 0.99	238 1.05	251 1.11	263 1.16
	PORTATA TOTALE REGENERATION DELIVERY	L/h Gpm US	270 1.19	310 1.36	343 1.51	383 1.69	404 1.78	421 1.85	437 1.92	452 1.99
EIETTORE NERO BLACK INJECTOR	ASPIRATO BRINE DELIVERY	L/h Gpm US	188 0.83	210 0.92	228 1.0	270 1.19	282 1.24	291 1.28	300 1.32	307 1.35
	MOTRICE MOTIVE/SLOW RINSE DELIVERY	L/h Gpm US	249 1.1		305 1.34	330 1.45	353 1.55	374 1.65	394 1.73	414 1.82
	PORTATA TOTALE REGENERATION DELIVERY	L/h Gpm US	435 1.92	489 2.15	533 2.35	600 2.64	635 2.80	665 2.93	694 3.06	721 3.17
EIETTORE GRIGIO GREY INJECTOR	ASPIRATO BRINE DELIVERY	L/h Gpm US	252 1.11	311 1.37	342 1.51	362 1.60	378 1.67	387 1.71	411 1.81	419 1.85
	MOTRICE MOTIVE/SLOW RINSE DELIVERY	L/h Gpm US	405 1.79	451 1.99	506 2.23	526 2.32	573 2.53	598 2.64	636 2.80	666 2.94
	PORTATA TOTALE REGENERATION DELIVERY	L/h Gpm US	657 2.90	762 3.36	848 3.74	888 3.91	951 4.20	985 4.34	1047 4.62	1085 4.78
EIETTORE GRIGIO GREY INJECTOR	ASPIRATO BRINE DELIVERY	L/h Gpm US	252 1.11	311 1.37	342 1.51	362 1.60	378 1.67	387 1.71	411 1.81	419 1.85
	MOTRICE MOTIVE/SLOW RINSE DELIVERY	L/h Gpm US	405 1.79	451 1.99	506 2.23	526 2.32	573 2.53	598 2.64	636 2.80	666 2.94
	PORTATA TOTALE REGENERATION DELIVERY	L/h Gpm US	657 2.90	762 3.36	848 3.74	888 3.91	951 4.20	985 4.34	1047 4.62	1085 4.78

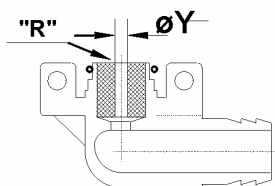

FLOW CONTROL		FLOW TO DRAIN		INJECTOR		
CODE "R"	mm	Y	Litri/ora	G.p.m. US	COLOR	CODE
070/1	3		320	1.41	BROWN	60-M
070/2	3.5		480	2.11	BLUE	60-B
070/3	4		700	3.08	BLUE or RED	
070/4	5		950	4.18	RED	60-R
070/5	6		1450	6.38	RED or BLACK	
					BLACK	60-N

### COMPONENTS OF STANDARD BASE VALVE

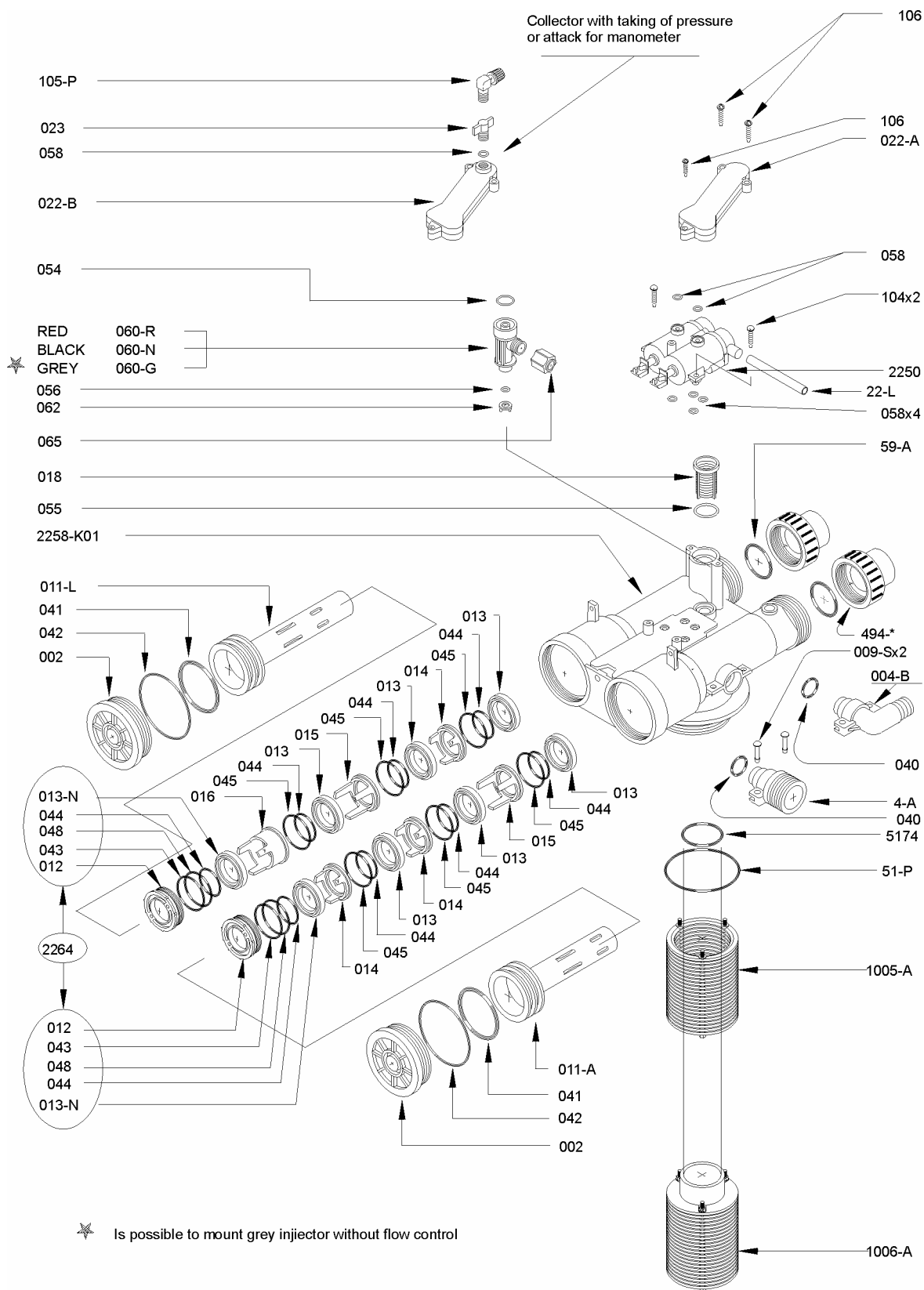

## STANDARD VOLUME VERSION

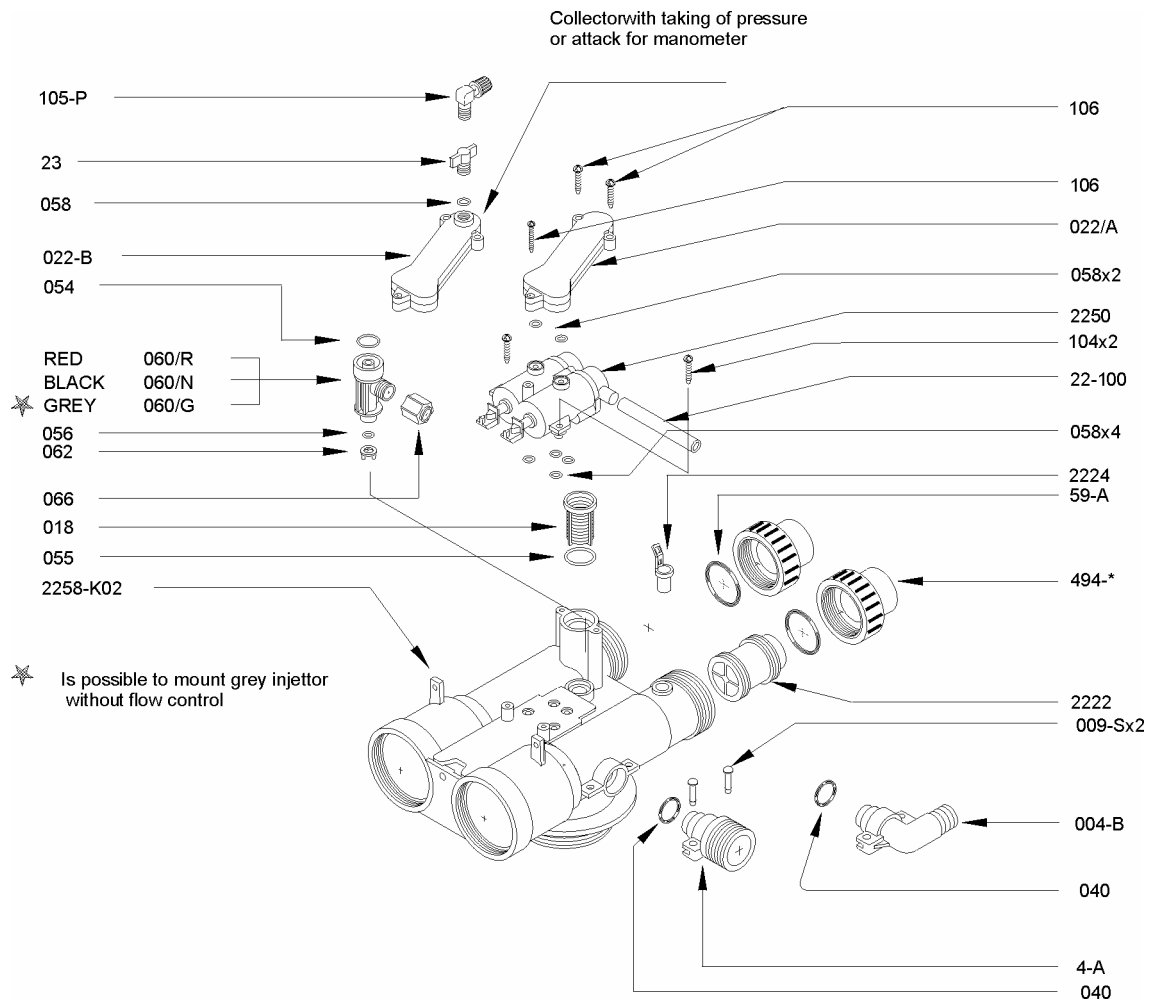

## Remote by-pass variation

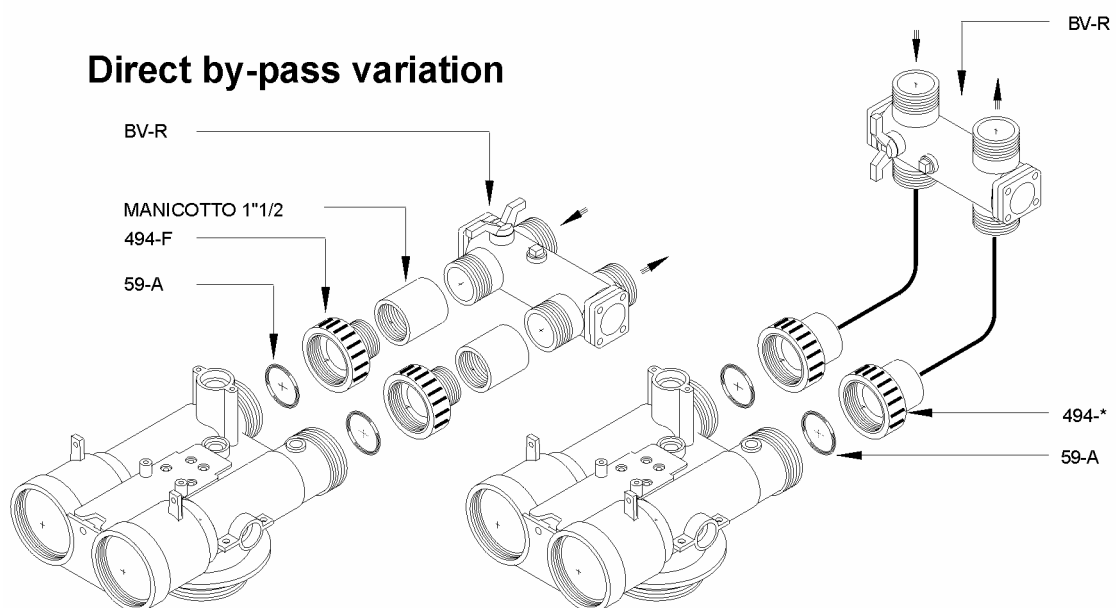

### STANDARD FILTRATION VERSION

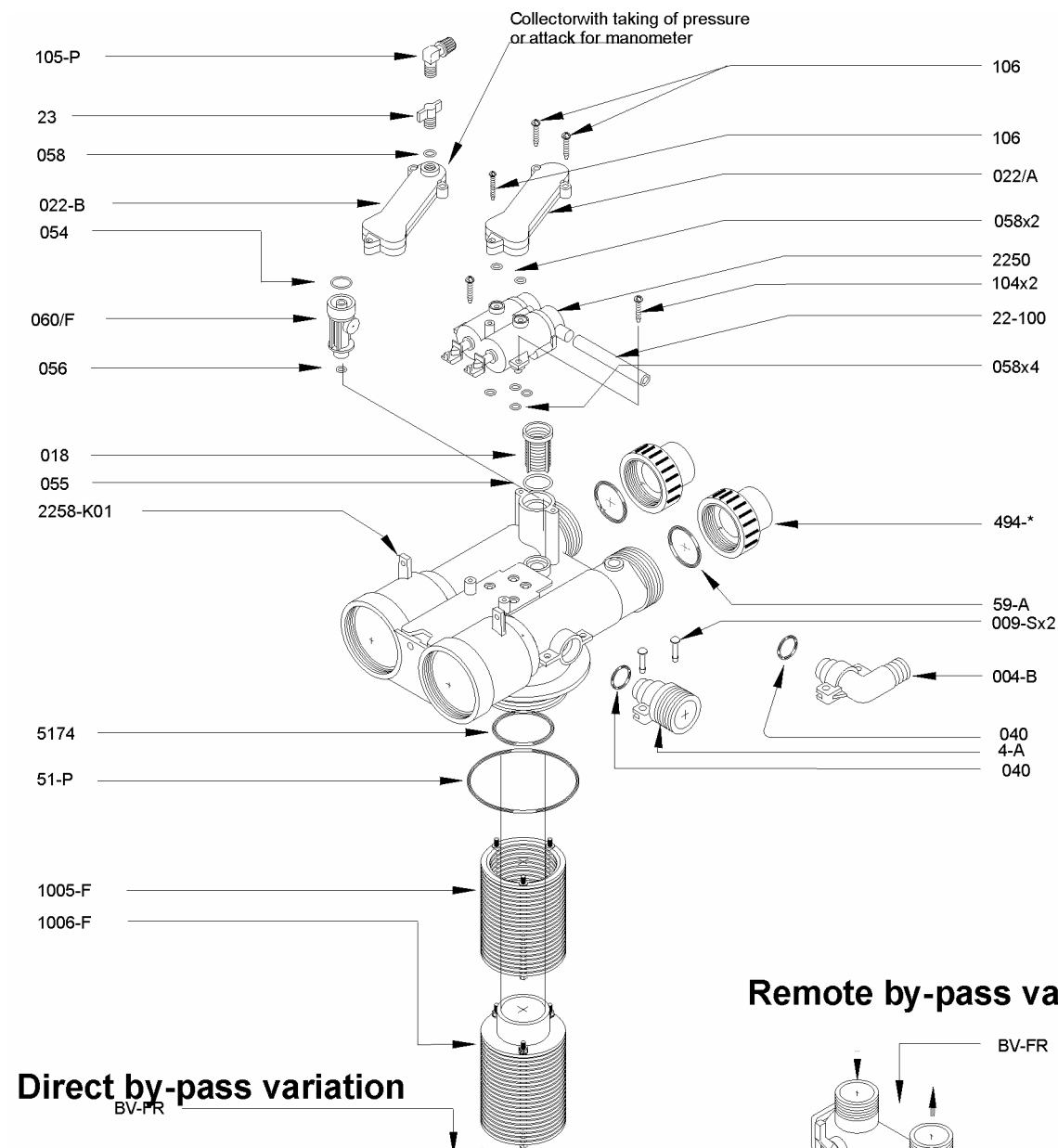

### Direct by-pass variation

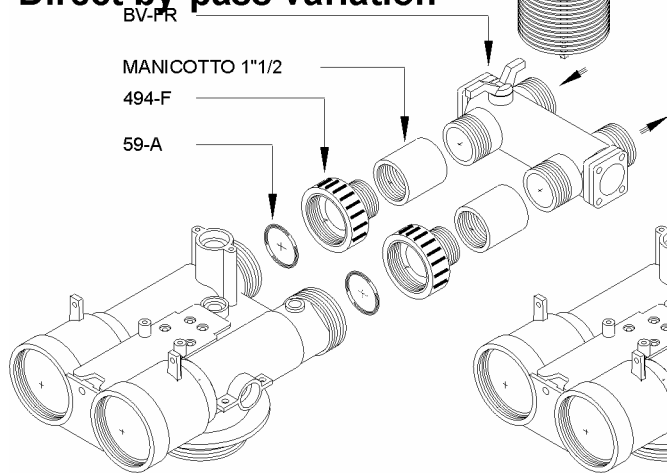

### Remote by-pass variation

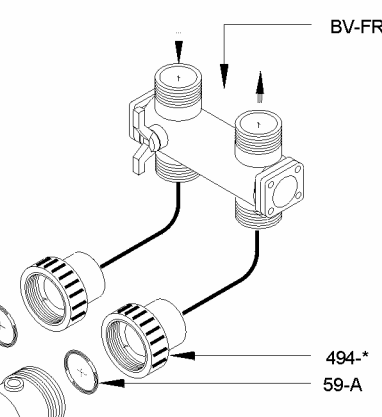



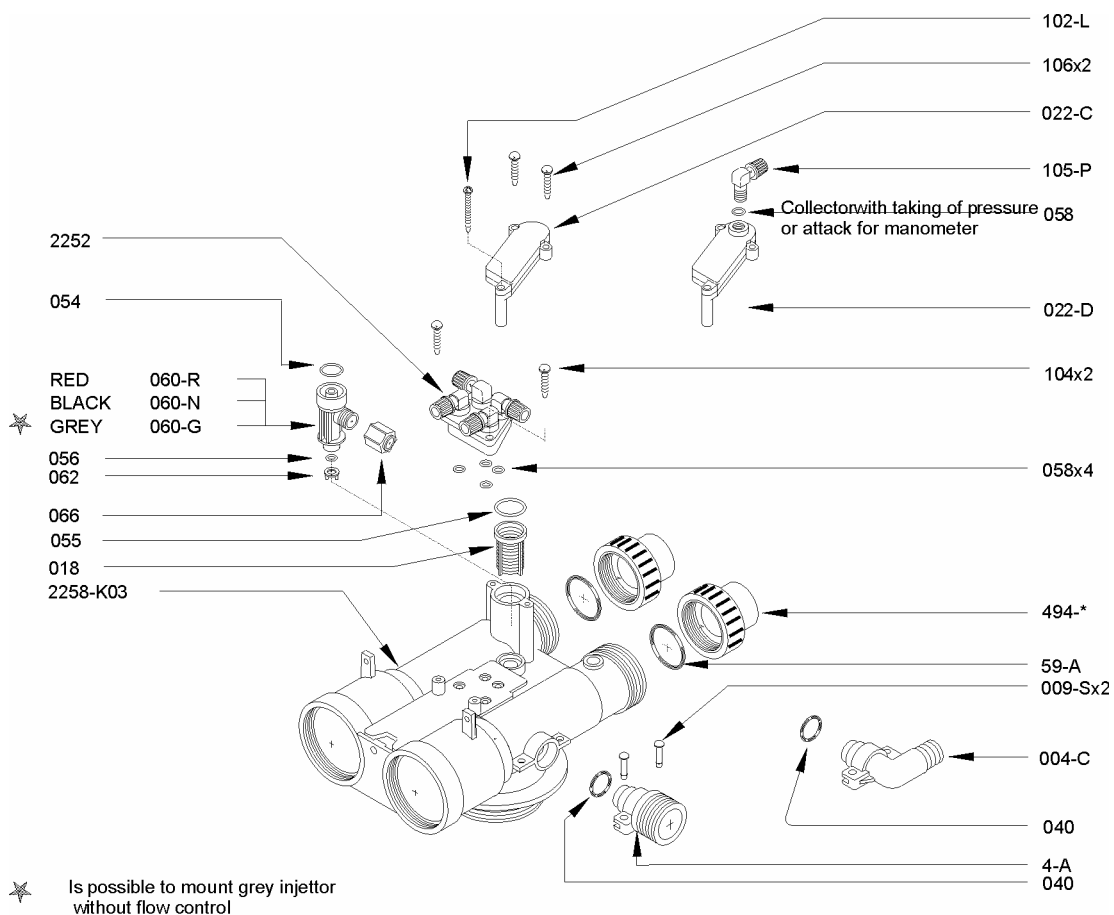

## DUPLEX AND DEMINERALISATION VALVE VERSION

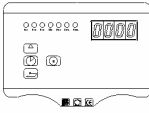
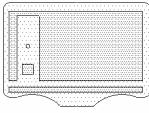
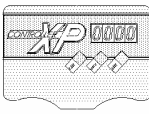
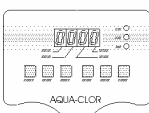
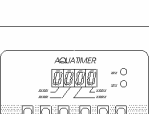
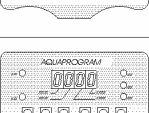

## CONTROLLER

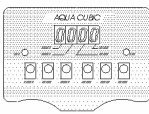
<p>This table shows a vast range of controllers to use in combination with the various versions of the V132 valve: from the most elementary electronic versions to a range that enables the most evolved combinations of controller/valves in making the latest generation systems in water treatment.</p>		Applications			Valve type					Function Versions					
		Softening	Filtration	Demineralisation	V132A	V132T	V132F	V132E	V132D	Time control	Volume control	Time / Volume control	Din connector	Chlorine producer	Economy probe
		Timer Code													
 <p><b>CONTROLLER STANDARD ELECTRONIC</b></p> <p>Electronic standard timer wich regenerates at the set hour in the allowed days the regeneration cycles are dependet upon a set rigereneration cycle scheme</p>	CS0	<input type="checkbox"/>	<input type="checkbox"/>	<input type="checkbox"/>	<input type="checkbox"/>			<input type="checkbox"/>							
	 <p><b>STANDARD PULSI</b></p> <p>Electromechanical controller with manual regeneration start, with the possibility of remote start function.</p>	SPO	<input type="checkbox"/>		<input type="checkbox"/>								1		
	SPO/08	<input type="checkbox"/>			<input type="checkbox"/>							1			
 <p><b>XP CONTROLLER</b></p> <p>Electronic controller with adjustable regeneration cycle state times, time or time-volume regeneration start with delayed intervention. Manual start too</p>	XPO	<input type="checkbox"/>	<input type="checkbox"/>	<input type="checkbox"/>	<input type="checkbox"/>			<input type="checkbox"/>							
	XPO/01	<input type="checkbox"/>			<input type="checkbox"/>			<input type="checkbox"/>	<input type="checkbox"/>						<input type="checkbox"/>
 <p><b>AQUA CLOR</b></p> <p>Electronic controller with adjustable regeneration times, volume regeneration or volume regeneration with delayed start. EEPROM device. Chlorine producer TIMER</p>	ACLO	<input type="checkbox"/>		<input type="checkbox"/>				<input type="checkbox"/>				<input type="checkbox"/>			
	ACLO/01	<input type="checkbox"/>			<input type="checkbox"/>			<input type="checkbox"/>	<input type="checkbox"/>	<input type="checkbox"/>		<input type="checkbox"/>	<input type="checkbox"/>	<input type="checkbox"/>	<input type="checkbox"/>
 <p><b>AQUA TIMER</b></p> <p>Electronic controller with adjustable regeneration cycle stage times. Time, volume, volume regeneration with delayed start. Remote ellettronic signal available on request.</p>	ATO	<input type="checkbox"/>	<input type="checkbox"/>	<input type="checkbox"/>	<input type="checkbox"/>			<input type="checkbox"/>							
	ATO/01	<input type="checkbox"/>			<input type="checkbox"/>			<input type="checkbox"/>	<input type="checkbox"/>	<input type="checkbox"/>					<input type="checkbox"/>
	ATO/02	<input type="checkbox"/>		<input type="checkbox"/>	<input type="checkbox"/>			<input type="checkbox"/>	<input type="checkbox"/>	<input type="checkbox"/>					
 <p><b>AQUA PROGRAM</b></p> <p>Electronic controller with adjustable regeneration cycle stage times: time, volume or volume regeneration start with remote start function. Optimises and controls regeneration cycle, command for another device available on request. Remote starter. INHIBIT. EEPROM device. (SIATA patent).</p>	APO/02	<input type="checkbox"/>		<input type="checkbox"/>	<input type="checkbox"/>			<input type="checkbox"/>	<input type="checkbox"/>	<input type="checkbox"/>	2			<input type="checkbox"/>	
 <p><b>AQUA CUBIC</b></p> <p>Electronic controller with adjustable regeneration times. Till 8 steps full regable. Usualy use for duplex plant. Volume regeneration start. EEPROM device.</p>	AC5	<input type="checkbox"/>	<input type="checkbox"/>				<input type="checkbox"/>	<input type="checkbox"/>				1			
	AC7	<input type="checkbox"/>	<input type="checkbox"/>				<input type="checkbox"/>	<input type="checkbox"/>					1		
 <p><b>AQUA IONIC</b></p> <p>Electronic controller. Specific for demineralization systems. Adjustable regeneration cycle stage times. Treated water quality control in micro siemens/cm. Regeneration start: Volume - Conductivity - Volume/conductivity Manual both too. Interface available for auxiliary services.</p>	AI5			<input type="checkbox"/>				<input type="checkbox"/>	<input type="checkbox"/>		3			<input type="checkbox"/>	
	AI7			<input type="checkbox"/>				<input type="checkbox"/>	<input type="checkbox"/>			3			<input type="checkbox"/>

### AUTOMATIC BY-PASS FOR DECALCIFERS

Automatic remote by-pass with mixer

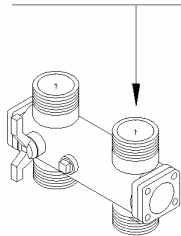

Code BV-R

Automatic remote by-pass with mixer and withdrawal

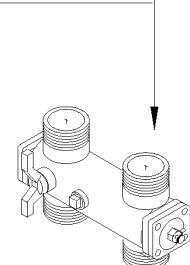

Code BV-RP

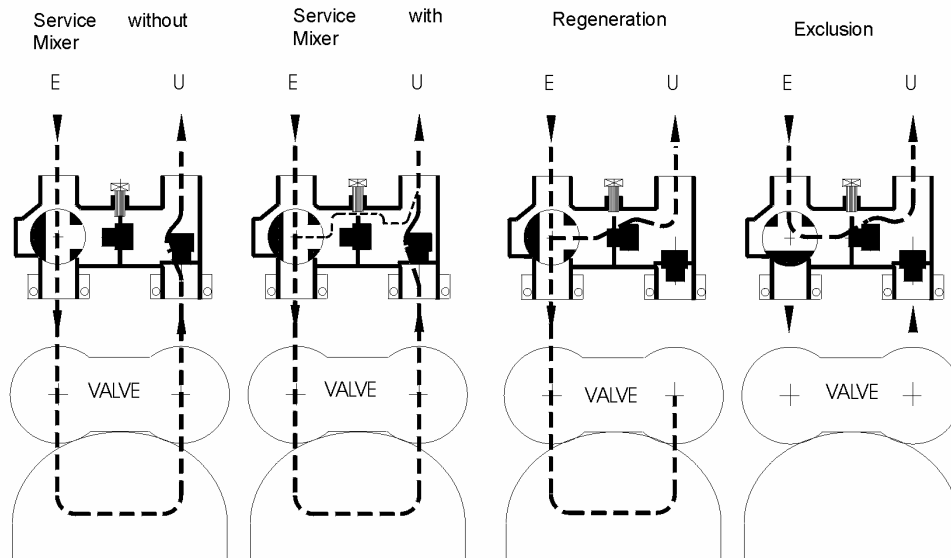

Service with Elevated pressure drop After the Tank Valve

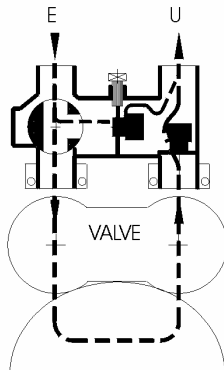

### BY-PASS FOR FILTERS

Remote By-pass for Filter

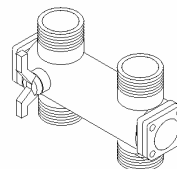

Code BV-FR

### REMOTE AUTOMATIC BY-PASS COMPONENTS

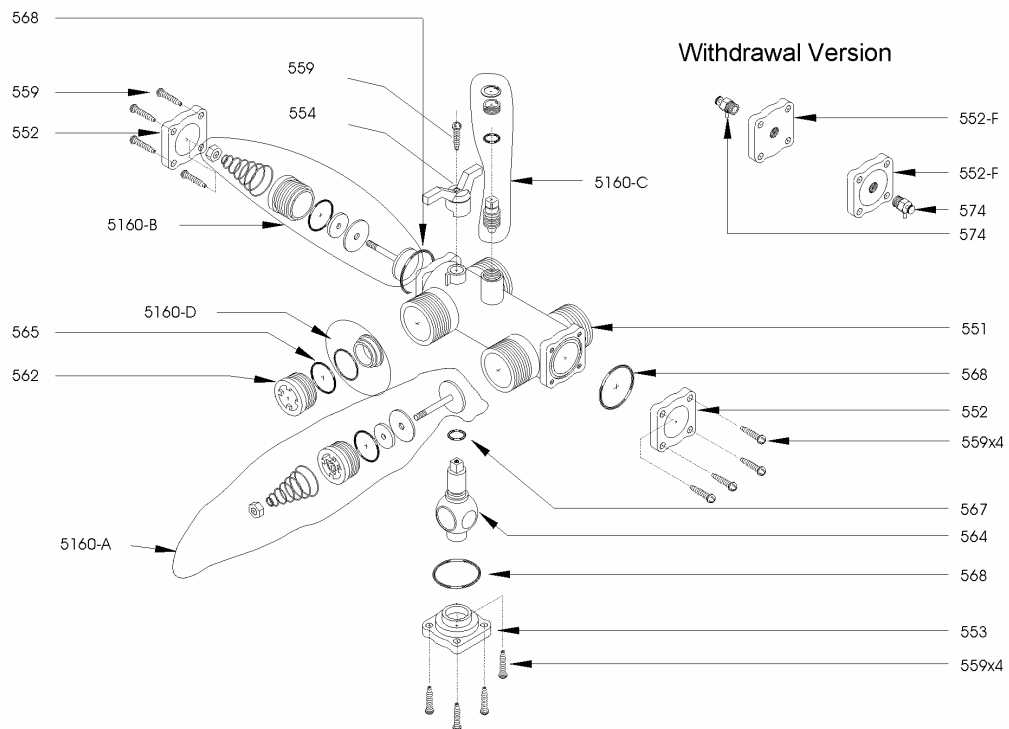

### REMOTE BY-PASS COMPONENTS FOR FILTRATION

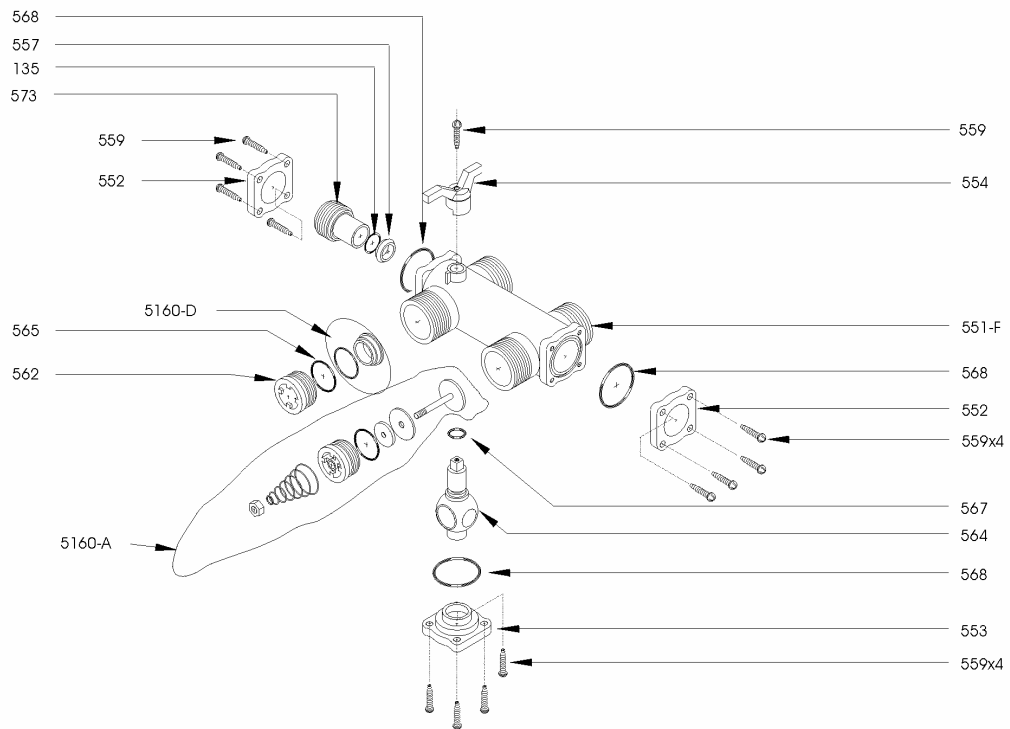

## AUTOMATIC BY-PASS FUNCTIONS

Proportional automatic by-pass functions consist in performances that facilitate system service with the following functions:

- a) delivery of untreated water during regeneration phases;
- b) partial delivery of water under use and service when withdrawals momentarily are higher than normal; Example: a momentary increase in water consumption creates a drop in pressure after the softening tank. The drop in water pressure as it comes out of the softener causes the automatic by-pass valve to open partially, making up for the increased demand.
- c) the by-pass has a mixer which, regulated to system functioning, obtains a residual hardness value in treated water in conformity with norms.
- d) in the event the system is equipped with a chlorine producer, it is advised to use a BVRPOD by-pass with incoming and outgoing withdrawal, so as to perform the checks set out in DPR 443.
- e) the by-pass makes it possible to exclude the valve or the entire system without interrupting water delivery.

### CHLORINE PRODUCER COMPONENTS

#### MALE/FEMALE

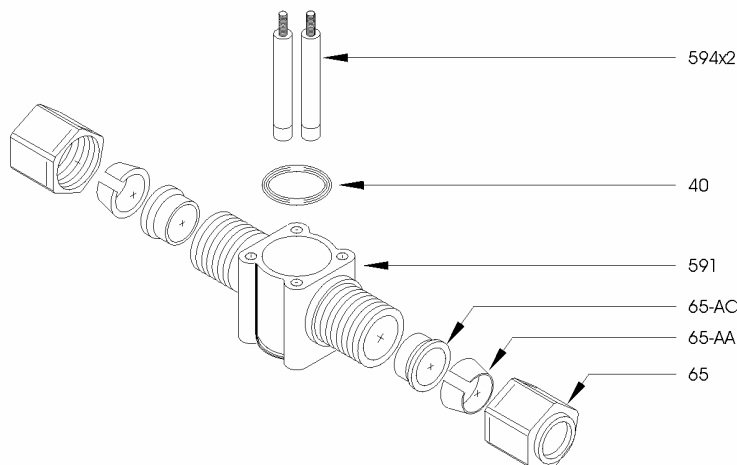
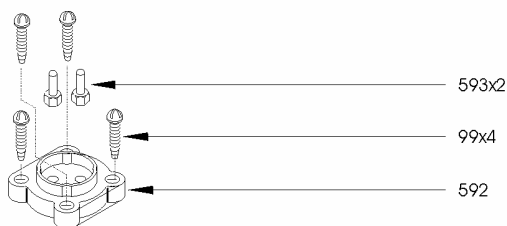
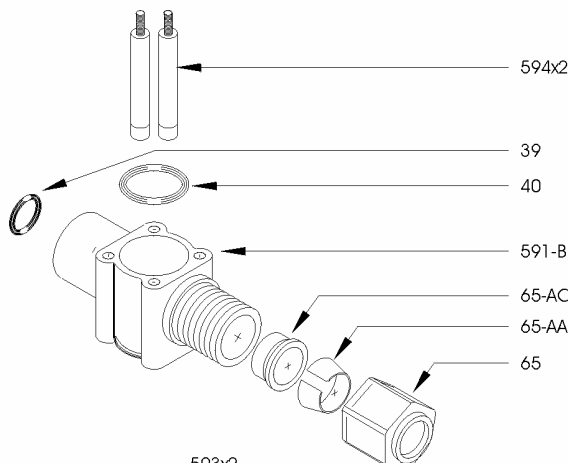
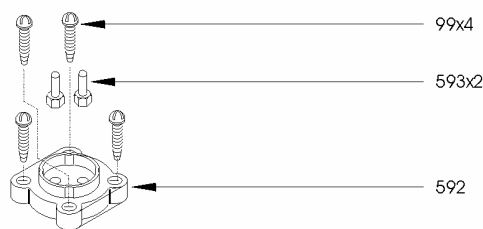
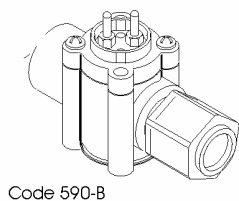

#### MALE/MALE

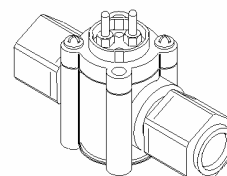

### CHLORINE PRODUCER FUNCTIONS

The chlorine producer is characterised by the possibility to automatically sterilise resin with each regeneration. For this function, of course, the valve must be equipped with the appropriate "cloro" electronic timer. This controller feeds electrically, during the phase of regeneration 2C, the cell electrolytic, producing so for the duration of the phase chlorine or is mixtures. The duration of the phase 2C rule so the quantity of chlorine that is necessary for the sterilisation of the resins.

## TIPS AND SUGGESTIONS

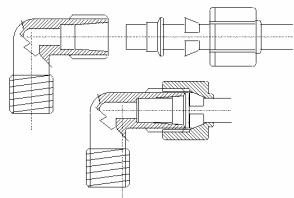

In connecting tubes and joints, using 1/8"  $\varnothing$  9.7 mm rigid or flexible tubes, respect tube size. Tubes of smaller dimensions can not guarantee retaining quality to pressure or pressure loss. Tubes of larger dimensions can force the housing and compromise the mounting of blocking rings and retaining quality as well.

In performing interventions on existing connections, always use new retaining rings, cod. 65-AC 65-AA. In assembling, take care that the tube end fully enters the housing to guarantee the best grip.

In the case of flexible tubes, screw on the nut tightly using only one's hands and then, if necessary, a wrench. In using rigid tubes, use a wrench.

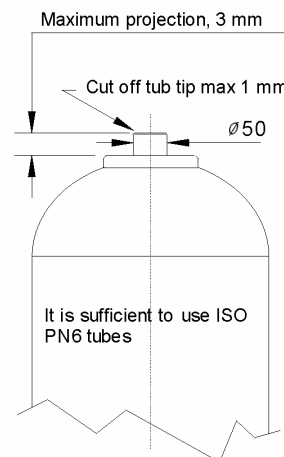

### Disassembly and reassembly of self-threading screws

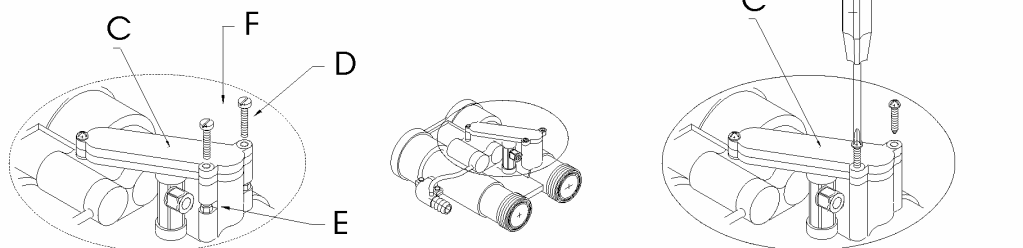

## PRECAUTIONS IN DISASSEMBLING "C" COLLECTOR

In disassembling the "C" collector, unscrew the screws slowly to avoid gripping between materials and screws.

Before remounting, carefully clean the hole and screws. Insert the screw in the hole and by hand, slowly turn it in direction "A" until reaching the beginning of the thread, then turn the screw in direction "B," still by hand, without forcing it.

Using a screwdriver, slowly screw in direction "B" until tight; do not force. Always perform these operations using normal screwdrivers; do not use automatic screwdrivers.

## MODIFICATION TO PERFORM IN CASE OF DAMAGE TO THREADED HOUSING OF "F" SELF-THREADING SCREWS

If during disassembly and reassembly of the "C" collector, the threads of the "F" screw housing, make a hole as indicated in "E," using a flat or squared large-grain file, 3 or 4 mm thick. Insert a 3M nut in this hole and replace the "F" screws with M3 "D" screws of the proper length (minimum 15 mm).

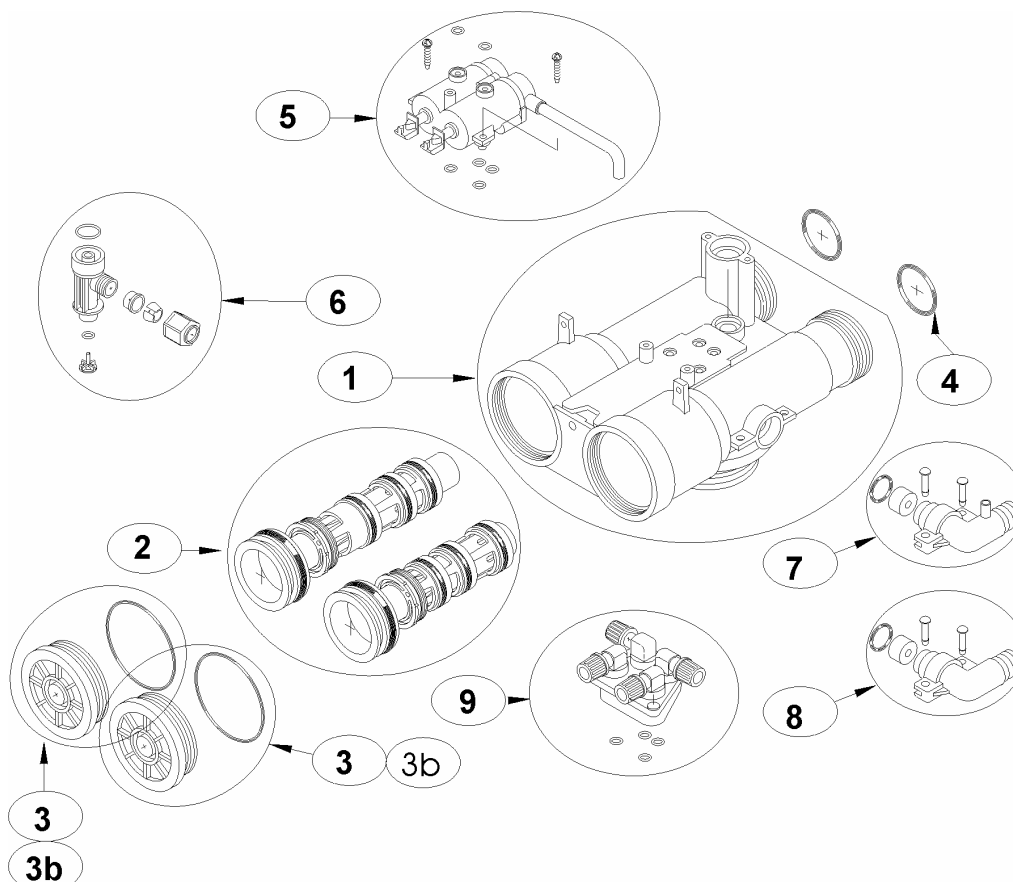

RIF .	CODE	DESCRITION
1	- 2258-k01	230 valve bodi service kit
	- 2258-k02	230 volume valve bodi kit
	- 2258-k03	230 demineralisation valve bodi kit
2	- 2230	Piston service kit
3	- 1916-a	Piston cover
3b	- 1916-b	Piston cover winth 1/8" threaded hole
4	- 59-a	External inlet-outlet port o-ring
5	- 2250	Pilot assembly
6	- 2231-r	Injector red
	- 2231-n	Injector black
	- 2231-g	Injector grey
7	- 2249-a	Drain manifold
7a	- 2249-c	Closed drain manifold
8	- 2252	Motive assembly connections



## ACCESSORIES AND SPARE PARTS

Ref. □	Code □	Description □
3	1916-A-05	valve cap with o-ring
4	1916-B-05	valve cap with o-ring and 1-8" g hole
5	590-A	Chlorine producer, ø 3-8" M/M
6	590-B	Chlorine producer, ø 3-8" F/M
7	494-B	PVC connection kit, 2"x1¼"
8	494-C	PVC connection kit, 2"xISO 40
9	494-F	Brass connection kit, 2"x1½"
10	494-S	2" gas – 1" ¼ npt pvc connection kit
11	2222	Complete turbine body
12	2296	1½" turbine water meter
13	2163	Conductivity sensor
14	2162-A	Anti-corrosion retaining valve, black (NaOH)
15	2162-K	Antiacid retaining valve, red (HCl)
16	2216	Temporised brine filling device
17	2161	Pin regulator
18	2238	V132 internal maintenance kit

### INTERVENTIONS OF ORDINARY MAINTENANCE

drawback	cause	corrective action
leakage from drain during the service	leakage from the pilot	<p>1) - to close water in entrance            2) - to close water in exit.            3) - to detach the tube of connection between the pilot and the drain collector .            4) - to remove the three screws that keep down the collector code 022 page. 9. To remove the two O-R 058 page. 9 and to replace them with two diskettes in soft rubber, thickness around 2mm. Or closing the passage with a thin sheet of plastic.            5) - to reassemble the collector 022, tightening the three screws taking care not to force.            6) - to reopen the inlet and the outlet of the water. Completed the procedure, if the leakage to drain has disappeared, the drawback is due to the pilot. In this case it's necessary a substitution.            If the leakage persists, the cause could be owed to a leakage of the chambers of the main cylinders. To identify the defective chamber, to proceed as to the 4 point , to close only one of the two O-R 058 beginning from the left one. the same operation will be effected, eventually, also for the right chamber.            The indication of what chamber is defective is the disappearance of the leakage, in relationship to the closed side of the pilot. To eliminate the defect, it is necessary to take a part the defective chamber, proceeding as below:            a) to -close water inlet and outlet            b) to -unscrew the cap of the defective chamber using the special tool or seeger pliers. The maintenance kit contains the right tools for the interventions of maintenance.            c) - to remove the stem of the pilot of the side related to the chamber.            d) - to extract the piston with a pliers, take out the inside pivot.            e) -to -verify that there are not scratches or other damages on the stem of the piston.            f) -if evident defects are not found on the piston, to unscrew the blockage ferrule of the spacer package , and to verify the state of the O-R 043-044-048 pag.9. If there isn't damage, it's advisable to replace all the gaskets O-R, verifying carefully the state of all. In the case to proceed is necessary to the complete removal of the spacer package, take care at the moment of the reassembly, to check the exact position page. 9.</p>
	Leakage from external command pilot	<p>Also this may be detected through a simple test:            1) Disconnect, in service position, pressure connectors 2 and 4 alternatively.            2) In case some water should leak from one of the pressure connectors from the pilot body, it means that the related pilot has some leaks and must be replaced. If the leakage is not due to the pilots, its cause has to be ascribed to a possible leakage of valve piston.</p>
	leakage of her valve through the system of the pistons	<p>In the case the leakage is found to originate only from the collector of draining, it is possible to determine easily in what chamber / piston there is the leakage.            7) -if the water of leakage to drain is hard water, it is due probably to the O-R of the ferrule 012 (043-044-048), inlet side, page. 9. Phase service pag.7.            8) - if the water of leakage to drain it results soft water, to replace the third O-R after the ferrule, page. 7 phase service.            To effect this intervention, to proceed as suitable to the point 6 paragraphs "a,b,c,d,e,f."</p>
Hardness' escape To the exit	probable leakage between entrance and exit O-R on the kept ac/bc	<p>9) -to extract the piston of the entrance, to check that there are not damages evident on the surface. if the piston results damaged, to replace it. Otherwise I would replace the first O-R departing from the end of the stem piston (entered). Page. 7 and 9. to effect this intervention, to proceed as suitable to the point 6°, paragraphs "a,b,c,d,e,f."            10) - to remove the valve from the cylinder, to replace the O-R 046 that it operates the estate between the top column and the pipe of the down column.</p>
It doesn't inhale brine	lack of pressure	<p>11) -to close the entrance to the valve, verifier that the manometer points at one non inferior pressure to 2 bar, if it results inferior, the pressure is insufficient.            12) - if to the point 11 the pressure is superior to 2 bar, to check the state of stoppage of the mechanical filter, installed to the entry of the plant. To get off it and to polish up. If after this operation the problem has not resolved, to proceed with the point 13.</p>
	obstruction pre filter over pilot. obstruction perforate injector. problems to the brain tank	<p>13) -to remove the collector 022 page. 9, to extract the filter 018 and to polish up it carefully, therefore to proceed to the point 14.            14) -to remove the injector 060 page. 9, to polish up the holes of the same carefully and to reassemble everything.            15) -if after this actions, the problem has not been eliminated, proceed to an accurate control of the complex connections and brine tank :            g) -to check that there are not obstructions in the system of connection.            h) -to check that the pole of the craft forced toward the lower part, disburses water.            i) -to check that the salt of the container, is not become hard.            j) -verify that the brine valve works in all regularly its components, doesn't have leakage on some terminal or link.</p>